

Geberit Mapress





Geberit Mapress CuNiFe is a sea water resistant material. It is especially suited to shipbuilding and has proved itself over many years with pipelines carrying salt water in lots of installations.

Preliminary Remarks

Introduction to Geberit Mapress CuNiFe

Geberit Mapress CuNiFe is a sea water resistant material. It is especially suited to shipbuilding and has proved itself over many years with pipelines carrying salt water in lots of installations.

The copper-nickel-iron alloy is used in shipbuilding for engine room systems, the supply of service water, pool water and heating water.

Thanks to the pressing technology, installations can be carried out reliably and quickly without complex welding and soldering.

Benefits of Geberit Mapress CuNiFe

Quick

Lower labour costs in comparison to conventional connection technology

Clean

Clean installation using the Geberit pressing technology. No consumables required.

Safe

- No danger of fire as no welding or soldering necessary
- Unpressed connections are easily identified
- It is easy to distinguish between product materials using the indicator colours
- Application ranges are easily identified by the plug colours
- No danger of confusion with third-party products

Economical

No consumables such as oxygen or gas required

Simple

Simple connection technology

Universal

Can be used for surface-mounted and concealed installations

Resistant to salt water

High resistance to corrosion due to the copper-nickel-iron alloy (CuNi10Fe1,6Mn)

Experienced

More than 30 years of practical experience in pressing technology

Always consider

The 6 stage pressing process

- Cut and deburr the pipe
- Mark the insertion depth on the pipe
- Prepare the fitting
- Insert the pipe in to the fitting
- Press with the appropriate jaw or collar
- Remove the pressing indicator

Check you are using the correct material for the required application. See page 8 for an in depth overview of the applications for Geberit Mapress CuNiFe.

Only Geberit Mapress system pipes are suitable to press Geberit Mapress CuNiFe fittings. To adapt on to existing or dissimilar materials you must use a threaded connection.

Use the correct tooling

Always check that you are using the correct tools, this can be checked in the Geberit Tooling Product Guide and Price List.

Make sure that the tools you are using are in a good condition and are calibrated. There should be a sticker on the tool, jaws, collars and adapters to tell you when the tool next needs calibrating.

Application overview - Geberit Mapress CuNiFe

Geberit Great Britain, Version: December 2019

Application purposes	Operating temperature	Maximum operating pressure	Pipes	Fittings
			CuNiFe	CuNiFe
Liquid media				
For cooling water without antifreeze agent	0–100 °C	13 bar / 1300 kPa	✓	✓
For cooling water with antifreeze agent	-30 – +120 °C	13 bar / 1300 kPa	✓	✓
For service water	0–100 °C	13 bar / 1300 kPa	✓	✓
For grey and black water with pH value > 6.0	0–100 °C	13 bar / 1300 kPa	✓	✓
For seawater	0–100 °C	13 bar / 1300 kPa	✓	✓
For extinguishing water (wet)	0–70 °C	13 bar / 1300 kPa	✓	✓
For sprinklers (wet)	0–70 °C	13 bar / 1300 kPa	✓	✓
For mineral and lubricating oil	Upon request	Upon request	✓	✓
For motor fuels (e.g. diesel)	Upon request	Upon request	✓	✓
Gaseous media				
For compressed air (oil purity class 0–3)	0–100 °C	10 bar / 1000 kPa	✓	✓
For compressed air (oil purity class 0–4)	0–100 °C	10 bar / 1000 kPa	✓	✓
For negative pressure ¹⁾	0–40 °C	Abs. \geq 0.2 bar / 20 kPa	✓	✓
For inert gases (e.g. nitrogen)	Upon request	Upon request	✓	✓

✓ Application generally approved if the defined additional requirements are met in accordance with the footnotes

1) Usable negative pressure for Geberit piping systems: The usable negative pressure is calculated on the basis of the air pressure at the place of installation minus the absolute pressure of 200 mbar.

Example: 980 mbar air pressure - 200 mbar absolute pressure = 780 mbar usable negative pressure in the piping system

2) Only use approved antifreeze agents

3) After Geberit approval

4) Oil purity class in accordance with ISO 8573-1:2010E; for details on moisture and particles, see technical information „Geberit Piping Systems for Compressed Air Installations“

Seal rings		Flat gaskets for screw connections			Flange gaskets
CIIR, black	FKM, blue	EPDM, black	FPM, green	Centellen® R WS 3825	Centellen® HD WS 3822
✓		✓			✓
✓ ²⁾				✓	✓
✓ ³⁾		✓ ³⁾			✓ ³⁾
✓		✓			✓
✓		✓			✓
✓		✓			✓
✓		✓			✓
	✓		✓		✓ ³⁾
	✓ ³⁾		✓ ³⁾		
Separator					
✓ ⁴⁾					✓
	✓ ⁴⁾		✓ ⁴⁾		✓
✓		✓			✓
✓ ³⁾		✓ ³⁾			✓ ³⁾

Dimensional changes for Geberit Mapress CuNiFe 2020

Geberit Great Britain, Version: December 2019

		DN	d, ø	H	H1	K	K1
Geberit Ma- press CuNiFe bend with plain ends 90°	67402	12	15 mm	5.9 cm	12.9 cm	0.0 cm	7.0 cm
	67404	20	22 mm	7.0 cm	14.2 cm	0.0 cm	7.2 cm
	67405	25	28 mm	7.9 cm	15.5 cm	0.0 cm	7.6 cm
	67406	32	35 mm	7.7 cm	15.4 cm	0.0 cm	7.7 cm
	67407	40	42 mm	9.0 cm	18.0 cm	0.0 cm	9.0 cm
	67408	50	54 mm	11.1 cm	20.5cm	0.0 cm	9.4 cm

System pipes 2.1972

Geberit Mapress CuNiFe system pipe

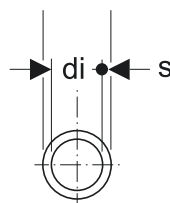
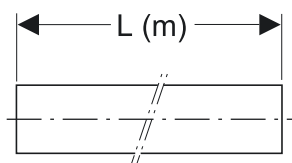
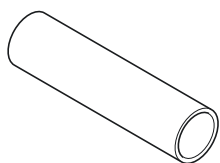

Application purposes

- For industry and shipbuilding
- Application overview – Geberit Mapress

Characteristics

- Seamlessly drawn
- Pipe end with black protective cap

Technical data

Material	CuNi10Fe1.6Mn, material no. 2.1972.11
Thermal expansion	0.017 mm/((m·K)
Thermal conductivity, pipe	50 W/((m·K)
Specific thermal capacity	377 J/(kg·K)

Art. no.	DN	d, ø [mm]	di, ø [mm]	s [mm]	L [m]	SU2 [m]
56319	12	15	13	1	6	6
56321	20	22	20	1	6	6
56326	20	22	19	1.5	6	6
56322	25	28	25	1.5	6	6
56323	32	35	32	1.5	6	6
56324	40	42	39	1.5	6	6
56325	50	54	51	1.5	6	6
56327	65	76.1	72.1	2	6	6
56328	80	88.9	84.9	2	6	6
56329	100	108	104	2.5	6	6

Couplings

Geberit Mapress CuNiFe coupling

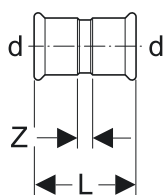
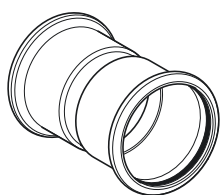

Application purposes

- For industry and shipbuilding
- Application overview – Geberit Mapress

Technical data

Material CuNi10Fe1.6Mn, material no. 2.1972.11

Characteristics

- Pressing indicator
- Leaky if unpressed
- Seal ring made of CIIR, black
- Pressing socket with transparent protection plug

Art. no.	DN	d, ø [mm]	L [cm]	Z [cm]	SU3 [pc.]	SU2 [pc.]	SU1 [pc.]
67002	12	15	4.8	0.8	50	10	
67004	20	22	5	0.8	50	10	
67005	25	28	5.4	0.8	50	10	
67006	32	35	6.2	1	50	10	
67007	40	42	7.1	1.1	24	4	
67008	50	54	8.3	1.3	24	4	
67009	65	76.1	14.1	3.5	5		1
67010	80	88.9	16.2	4.2	5		1
67011	100	108	19.4	4.4	5		1

Geberit Mapress CuNiFe slip coupling

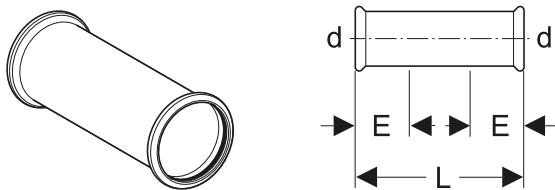

Application purposes

- For industry and shipbuilding
- Application overview – Geberit Mapress

Technical data

Material CuNi10Fe1.6Mn, material no. 2.1972.11

Characteristics

- Pressing indicator
- Leaky if unpressed
- Seal ring made of CIIR, black
- Pressing socket with transparent protection plug

Art. no.	DN	d, \varnothing [mm]	E [cm]	L [cm]	Z [cm]	SU3 [pc.]	SU2 [pc.]	SU1 [pc.]
67102	12	15	2.5	8	3		10	
67104	20	22	2.5	8.4	3.4		10	
67105	25	28	3	9.1	3.1		10	
67106	32	35	3	10.2	4.2		10	
67107	40	42	4	12	4		4	
67108	50	54	4	14	6		4	
67109	65	76.1	6	23	11	5		1
67110	80	88.9	7	26	12			1
67111	100	108	8	3	15			1

Reducers

Geberit Mapress reducer with plain end

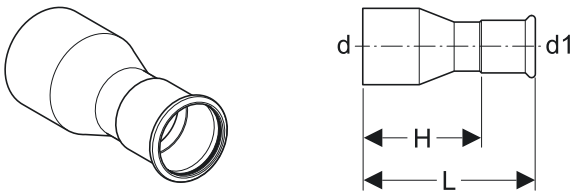

Application purposes

- For industry and shipbuilding
- Application overview – Geberit Mapress

Technical data

Material CuNi10Fe1.6Mn, material no. 2.1972.11

Characteristics

- Pressing indicator
- Leaky if unpressed
- Seal ring made of CIIR, black
- Pressing socket with transparent protection plug

Art. no.	DN	d, \varnothing [mm]	d1, \varnothing [mm]	L [cm]	H [cm]	SU3 [pc.]	SU2 [pc.]	SU1 [pc.]
67305	20/12	22	15	5.9	3.9		10	
67307	25/12	28	15	6.6	4.6		10	
67309	25/20	28	22	6	3.9		10	
67312	32/20	35	22	7.1	5		10	
67313	32/25	35	28	6.8	4.5		10	
67317	40/25	42	28	8.3	6		4	
67318	40/32	42	35	7.6	5		4	
67323	50/32	54	35	10.6	8	12	4	
67324	50/40	54	42	8.9	5.9	24	4	
67337	65/40	76.1	42	12.7	9.7			1
67325	65/50	76.1	54	14.6	11.1	5		1
67338	80/50	88.9	54	16.3	12.8			1
67327	80/65	88.9	76.1	16	10.7			1
67346	100/65	108	76.1	18.4	13.1			1
67330	100/80	108	88.9	20.4	14.4			1

Bends

Geberit Mapress CuNiFe bend

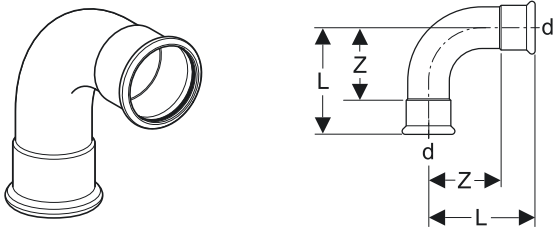

Application purposes

- For industry and shipbuilding
- Application overview – Geberit Mapress

Technical data

Material CuNi10Fe1.6Mn, material no. 2.1972.11

Characteristics

- Pressing indicator
- Leaky if unpressed
- Seal ring made of CIIR, black
- Pressing socket with transparent protection plug

Art. no.	DN	d, ϕ [mm]	L [cm]	Z [cm]	SU3 [pc.]	SU2 [pc.]	SU1 [pc.]
arc/angel: 15°							
68716	12	15	3	1		10	
68718	20	22	3.3	1.2		10	
68719	25	28	3.6	1.3		10	
68720	32	35	3.2	0.6		10	
68721	40	42	3.7	0.7		4	
68722	50	54	4.4	0.9		4	
68723	65	76.1	7.5	2.2			1
68724	80	88.9	8.5	2.5			1
68725	100	108	10.3	2.8			1
arc/angel: 30°							
68736	12	15	3.3	1.3		10	
68738	20	22	3.7	1.6		10	
68739	25	28	4.1	1.8		10	
68740	32	35	3.7	1.1		10	
68741	40	42	4.4	1.4		4	
68742	50	54	5.2	1.7		4	
68743	65	76.1	8.8	3.5	5		1
68744	80	88.9	10.1	4.1			1
68745	100	108	12.2	4.7			1

Art. no.	DN	d, ø [mm]	L [cm]	Z [cm]	SU3 [pc.]	SU2 [pc.]	SU1 [pc.]
arc/angel: 45°							
68602	12	15	3.6	1.6	50	10	
68604	20	22	3.2	1.1	50	10	
68605	25	28	3.7	1.4	50	10	
68606	32	35	4.3	1.7	50	10	
68607	40	42	5.1	2.1	24	4	
68608	50	54	6.2	2.7	24	4	
68609	65	76.1	10.3	5	5		1
68610	80	88.9	11.7	5.7	5		1
68611	100	108	14.3	6.8	5		1
arc/angel: 60°							
68804	12	15	3.3	2		10	
68806	20	22	3.7	2.6		10	
68807	25	28	4.1	3.1		10	
68808	32	35	3.7	2.4		10	
68809	40	42	4.4	2.9		4	
68810	50	54	5.2	3.7		4	
68811	65	76.1	8.8	6.4			1
68812	80	88.9	10.1	7.6			1
68813	100	108	12.2	9.1			1
arc/angel: 90°							
68102	12	15	3.8	1.8	50	10	
68104	20	22	4.7	2.6	50	10	
68105	25	28	5.7	3.4	50	10	
68106	32	35	6.8	4.2	50	10	
68107	40	42	8	5	24	4	
68108	50	54	10	6.5	24	4	
68109	65	76.1	15.9	10.6	5		1
68110	80	88.9	18.5	12.5	5		1
68111	100	108	23	15.5	5		1

Geberit Mapress CuNiFe bend with plain end

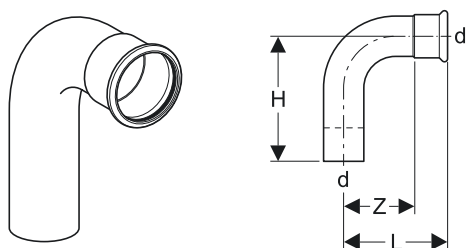

Application purposes

- For industry and shipbuilding
- Application overview – Geberit Mapress

Characteristics

- Pressing indicator
- Leaky if unpressed
- Seal ring made of CIIR, black
- Pressing socket with transparent protection plug

Technical data

Material CuNi10Fe1.6Mn, material no. 2.1972.11

Art. no.	DN	d, \varnothing [mm]	L [cm]	H [cm]	Z [cm]	SU3 [pc.]	SU2 [pc.]	SU1 [pc.]
arc/angel: 15°								
68726	12	15	3	4	1		10	
68728	20	22	3.3	4.1	1.2		10	
68729	25	28	3.6	4.3	1.3		10	
68730	32	35	3.2	4.1	0.6		10	
68731	40	42	3.7	4.7	0.7		4	
68732	50	54	4.4	5.5	0.9		4	
68733	65	76.1	7.5	8.4	2.2			1
68734	80	88.9	8.5	9.5	2.5			1
68735	100	108	10.3	11.7	2.8			1
arc/angel: 30°								
68746	12	15	3.3	4.3	1.3		10	
68748	20	22	3.7	4.6	1.6		10	
68749	25	28	4.1	4.8	1.8		5	
68750	32	35	3.7	4.6	1.1		10	
68751	40	42	4.4	5.4	1.4		4	
68752	50	54	5.2	6.3	1.7		4	
68753	65	76.1	8.8	9.7	3.5			1
68754	80	88.9	10.1	11.1	4.1			1
68755	100	108	12.2	13.6	4.7			1

Art. no.	DN	d, ø [mm]	L [cm]	H [cm]	Z [cm]	SU3 [pc.]	SU2 [pc.]	SU1 [pc.]
arc/angel: 45°								
67702	12	15	3.6	4.5	1.6		10	
67704	20	22	3.2	4.4	1.1		10	
67705	25	28	3.7	5	1.4		10	
67706	32	35	4.3	5.2	1.7		10	
67707	40	42	5.1	6.1	2.1	24	4	
67708	50	54	6.2	7.3	2.7	24	4	
67709	65	76.1	10.3	11.1	5	5		1
67710	80	88.9	11.7	12.8	5.7	5		1
67711	100	108	14.3	15.8	6.8			1
arc/angel: 60°								
68814	12	15	4	5	2		10	
68816	20	22	4.7	5.6	2.6		10	
68817	25	28	5.4	6.1	3.1		10	
68818	32	35	5	5.9	2.4		10	
68819	40	42	5.9	6.9	2.9		4	
68820	50	54	7.2	8.3	3.7		4	
68821	65	76.1	11.7	12.6	6.4			1
68822	80	88.9	13.6	14.6	7.6			1
68823	100	108	16.6	18	9.1			1
arc/angel: 90°								
68302	12	15	3.8	5.1	1.8		10	
68304	20	22	4.7	6	2.6	50	10	
68305	25	28	5.7	6.6	3.4	50	5	
68306	32	35	6.8	7.7	4.2		10	
68307	40	42	8	9	5	24	4	
68308	50	54	10	11.1	6.5	24	4	
68309	65	76.1	15.9	16.7	10.6	5		1
68310	80	88.9	18.5	19.5	12.5			1
68311	100	108	23	24.1	15.5			1

Geberit Mapress CuNiFe bend with plain ends 90°

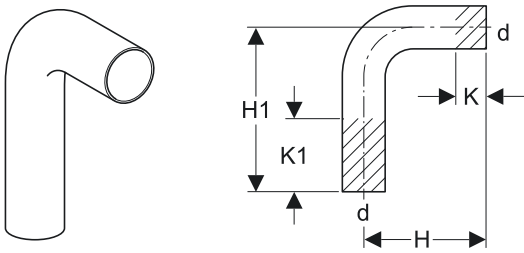

Application purposes

- For industry and shipbuilding
- Application overview – Geberit Mapress

Technical data

Material CuNi10Fe1.6Mn, material no. 2.1972.11

Art. no.	DN	d, \varnothing [mm]	H [cm]	H1 [cm]	K [cm]	K1 [cm]	SU2 [pc.]
67402	12	15	7	12	2.2	7.2	10
67404	20	22	7	12	0.9	5.9	5
67405	25	28	8	12	0.7	4.7	10
67406	32	35	12	20	3	11	10
67407	40	42	15	25	4.4	14.4	4
67408	50	54	20	30	6.5	16.5	4

T-pieces

Geberit Mapress CuNiFe bend, equal

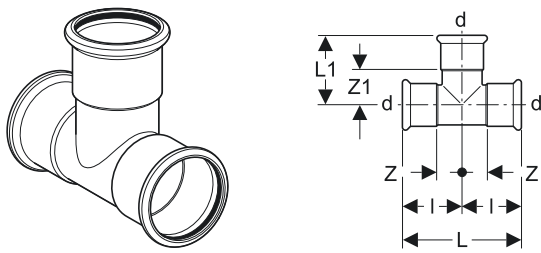

Application purposes

- For industry and shipbuilding
- Application overview – Geberit Mapress

Technical data

Material CuNi10Fe1.6Mn, material no. 2.1972.11

Characteristics

- Pressing indicator
- Leaky if unpressed
- Seal ring made of CIIR, black
- Pressing socket with transparent protection plug

Art. no.	DN	d, ø [mm]	L [cm]	L1 [cm]	l [cm]	Z [cm]	Z1 [cm]	SU2 [pc.]	SU1 [pc.]
68002	12	15	6.4	4	3.2	1.2	2	10	
68004	20	22	7.4	4.5	3.7	1.6	2.4	10	
68005	25	28	8.4	5.1	4.2	1.9	2.8	10	
68006	32	35	10	5.9	5	2.4	3.3	10	
68007	40	42	11.4	6.6	5.7	2.7	3.6	4	
68008	50	54	13.8	7.2	6.9	3.4	3.7	4	
68009	65	76.1	23	11	11.5	6.2	5.7		1
68010	80	88.9	26	12.7	13	7	6.7		1
68011	100	108	31	15.3	15.5	8	7.8		1

Geberit Mapress CuNiFe T-piece, reduced

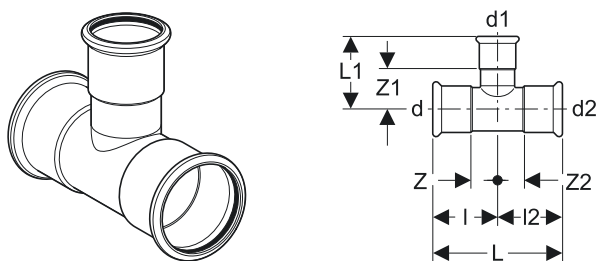

Application purposes

- For industry and shipbuilding
- Application overview – Geberit Mapress

Characteristics

- Pressing indicator
- Leaky if unpressed
- Seal ring made of CIIR, black
- Pressing socket with transparent protection plug

Technical data

Material CuNi10Fe1.6Mn, material no. 2.1972.11

Art. no.	DN	d, ø [mm]	d1, ø [mm]	d2, ø [mm]	L [cm]	L1 [cm]	l [cm]	l2 [cm]	Z [cm]	Z1 [cm]	Z2 [cm]	SU2 [pc.]	SU1 [pc.]
67206	20/12/20	22	15	22	7.4	4.4	3.7	3.7	1.6	2.4	1.6	10	
67209	25/12/25	28	15	28	8.4	4.7	4.2	4.2	1.9	2.7	1.9	10	
67211	25/20/25	28	22	28	8.4	4.8	4.2	4.2	1.9	2.7	1.9	10	
67212	32/12/32	35	15	35	10	4.9	5	5	2.4	2.9	2.4	10	
67214	32/20/32	35	22	35	10	5.2	5	5	2.4	2.1	2.4	10	
67215	32/25/32	35	28	35	10	5.5	5	5	2.4	3.2	2.4	10	
67218	40/20/40	42	22	42	11.4	5.4	5.7	5.7	2.7	3.3	2.7	4	
67219	40/25/40	42	28	42	11.4	5.8	5.7	5.7	2.7	3.5	2.7	4	
67220	40/32/40	42	35	42	11.4	6.2	5.7	5.7	2.7	3.6	2.7	4	
67227	50/20/50	54	22	54	13.8	6.1	6.9	6.9	3.4	4	3.4	4	
67228	50/25/50	54	28	54	13.8	6.4	6.9	6.9	3.4	4.1	3.4	4	
67225	50/32/50	54	35	54	13.8	6.8	6.9	6.9	3.4	4.2	3.4	4	
67226	50/40/50	54	42	54	13.8	7.2	6.9	6.9	3.4	4.2	3.4	4	
67229	65/20/65	76.1	22	76.1	23	7.2	11.5	11.5	6.2	5.1	6.2		1
67230	65/25/65	76.1	28	76.1	23	7.5	11.5	11.5	6.2	5.2	6.2		1
67231	65/32/65	76.1	35	76.1	23	7.9	11.5	11.5	6.2	5.3	6.2		1
67252	65/40/65	76.1	42	76.1	23	8.3	11.5	11.5	6.2	5.3	6.2		1
67253	65/50/65	76.1	54	76.1	23	8.9	11.5	11.5	6.2	5.4	6.2		1
67233	80/20/80	88.9	22	88.9	26	7.8	13	13	7	5.7	7		1
67250	80/25/80	88.9	28	88.9	26	8.1	13	13	7	5.8	7		1
67251	80/32/80	88.9	35	88.9	26	8.5	13	13	7	5.9	7		1
67239	80/40/80	88.9	42	88.9	26	8.9	13	13	7	5.9	7		1
67260	80/50/80	88.9	54	88.9	26	9.5	13	13	7	6	7		1
67261	80/65/80	88.9	76.1	88.9	26	11.6	13	13	7	6.3	7		1
67244	100/20/100	108	22	108	31	8.8	15.5	15.5	8	6.7	8		1

Art. no.	DN	d, ø [mm]	d1, ø [mm]	d2, ø [mm]	L [cm]	L1 [cm]	l [cm]	l2 [cm]	Z [cm]	Z1 [cm]	Z2 [cm]	SU2 [pc.]	SU1 [pc.]
67245	100/25/100	108	28	108	31	9.1	15.5	15.5	8	6.8	8		1
67246	100/32/100	108	35	108	31	9.5	15.5	15.5	8	6.9	8		1
67247	100/40/100	108	42	108	31	9.9	15.5	15.5	8	6.9	8		1
67248	100/50/100	108	54	108	31	10.5	15.5	15.5	8	7	8		1
67269	100/65/100	108	76.1	108	31	12.6	15.5	15.5	8	7.3	8		1
67270	100/80/100	108	88.9	108	31	13.7	15.5	15.5	8	7.7	8		1

Geberit Mapress CuNiFe T-piece with female thread

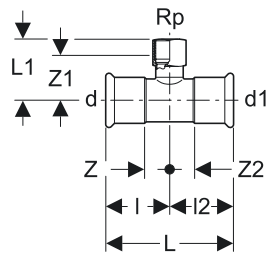
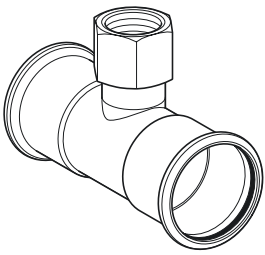

Application purposes

- For industry and shipbuilding
- Application overview – Geberit Mapress

Characteristics

- Pressing indicator
- Leaky if unpressed
- Seal ring made of CIIR, black
- Pressing socket with transparent protection plug

Technical data

Material CuNi10Fe1.6Mn, material no. 2.1972.11

Art. no.	DN	d, ø [mm]	Rp ["]	d1, ø [mm]	L [cm]	L1 [cm]	l [cm]	l2 [cm]	Z [cm]	Z1 [cm]	Z2 [cm]	SU2 [pc.]	SU1 [pc.]
67344	12/15/12	15	1/2	15	6.4	3.7	3.2	3.2	0.8	2.4	0.8	10	
67347	20/15/20	22	1/2	22	7.4	4.1	3.7	3.7	1.6	2.8	1.6	10	
67348	20	22	3/4	22	7.4	4.6	3.7	3.7	1.6	3.1	1.6	10	
67349	25/15/25	28	1/2	28	8.4	4.4	4.2	4.2	1.9	3.1	1.9	10	
67350	25/20/25	28	3/4	28	8.4	4.6	4.2	4.2	1.9	3.1	1.9	10	
67352	32/15/32	35	1/2	35	10	4.8	5	5	2.4	3.5	2.4		1
67353	32/20/32	35	3/4	35	10	5.3	5	5	2.4	4	2.4		1
67356	40/15/40	42	1/2	42	11.4	5.1	5.7	5.7	2.7	3.8	2.7		1
67357	40/20/40	42	3/4	42	11.4	5.6	5.7	5.7	2.7	4.3	2.7		1
67360	50/15/50	54	1/2	54	13.8	5.7	6.9	6.9	3.4	4.4	3.4		1
67361	50/20/50	54	3/4	54	13.8	6.2	6.9	6.9	3.4	4.9	3.4		1
67366	65/20/65	76.1	3/4	76.1	23	7	11.5	11.5	6.2	5.5	6.2		1
67369	80/20/80	88.9	3/4	88.9	26	7.6	13	13	7	6.1	7		1
67373	100/20/100	108	3/4	108	31	8.6	15.5	15.5	8	7.1	8		1

Adaptors, permanent

Geberit Mapress CuNiFe adaptor with male thread

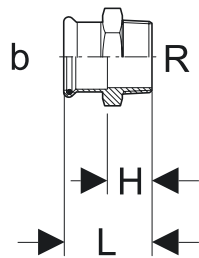
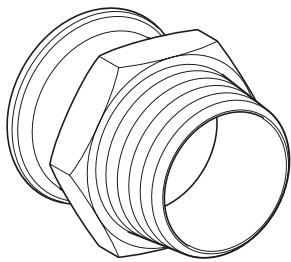

Application purposes

- For industry and shipbuilding
- Application overview – Geberit Mapress

Characteristics

- Pressing indicator
- Leaky if unpressed
- Seal ring made of CIIR, black
- Pressing socket with transparent protection plug

Technical data

Material CuNi10Fe1.6Mn, material no. 2.1972.11

Art. no.	DN	d, ø [mm]	R ["]	L [cm]	H [cm]	SU3 [pc.]	SU2 [pc.]
68703	12/15	15	1/2	5.3	3.3	50	10
68715	20/15	22	1/2	5.4	3.3		10
68707	20	22	3/4	5.8	3.7		10
68708	25	28	1	6.4	4.1		10
68709	32	35	1 1/4	7.2	4.6		10
68710	40	42	1 1/2	7.7	4.7		4
68711	50	54	2	8.9	5.4		4

Geberit Mapress CuNiFe adaptor with female thread

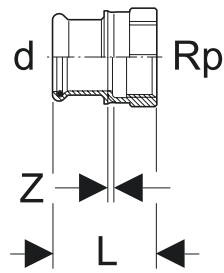
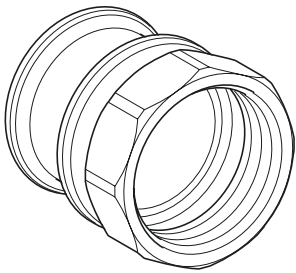

Application purposes

- For industry and shipbuilding
- Application overview – Geberit Mapress

Characteristics

- Pressing indicator
- Leaky if unpressed
- Seal ring made of CIIR, black
- Pressing socket with transparent protection plug

Technical data

Material CuNi10Fe1.6Mn, material no. 2.1972.11

Art. no.	DN	d, ϕ [mm]	Rp ["]	L [cm]	Z [cm]	SU2 [pc.]
67802	12/15	15	1/2	5.5	2.2	10
67805	20/15	22	1/2	5.6	2.2	10
67806	20	22	3/4	5.8	2.2	10
67809	25	28	1	6.4	2.4	10
67811	32	35	1 1/4	7	2.5	10
67814	40	42	1 1/2	7.4	2.5	4
67818	50	54	2	8.9	3.1	4

Geberit Mapress CuNiFe bend adaptor 90° with male thread

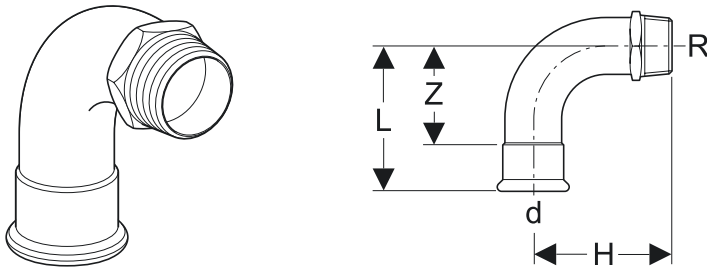

Application purposes

- For industry and shipbuilding
- Application overview – Geberit Mapress

Characteristics

- Pressing indicator
- Leaky if unpressed
- Seal ring made of CIIR, black
- Pressing socket with transparent protection plug

Technical data

Material CuNi10Fe1.6Mn, material no. 2.1972.11

Art. no.	DN	d, ø [mm]	R ["]	L [cm]	H [cm]	Z [cm]	SU2 [pc.]
67515	12/15	15	1/2	3.8	7.5	1.8	10
67516	20/15	22	1/2	4.7	8.4	2.6	10
67517	20	22	3/4	4.7	8.8	2.6	10
67518	25	28	1	5.7	9.7	3.4	10
67519	32	35	1 1/4	6.8	11.2	4.2	10
67520	40	42	1 1/2	8	12.6	5	4
67521	50	54	2	10	15.3	6.5	4

Geberit Mapress CuNiFe bend adaptor 90° with female thread

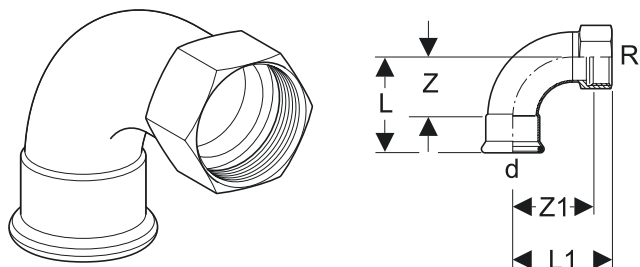

Application purposes

- For industry and shipbuilding
- Application overview – Geberit Mapress

Characteristics

- Pressing indicator
- Leaky if unpressed
- Seal ring made of CIIR, black
- Pressing socket with transparent protection plug

Technical data

Material CuNi10Fe1.6Mn, material no. 2.1972.11

Art. no.	DN	d, ø [mm]	Rp ["]	L [cm]	L1 [cm]	Z [cm]	Z1 [cm]	SU2 [pc.]
67503	12/15	15	1/2	3.8	7.7	1.8	6.4	10
67506	20/15	22	1/2	4.7	8.6	2.6	7.3	10
67507	20	22	3/4	4.7	8.8	2.6	7.3	10
67508	25	28	1	5.7	9.7	4	7.8	10
67509	32	35	1 1/4	6.8	11	4.2	9.1	10
67510	40	42	1 1/2	8	12.3	5	10.4	4
67511	50	54	2	10	15.3	6.5	13	4

Adaptors and connections, detachable

Geberit Mapress CuNiFe adaptor union with male thread

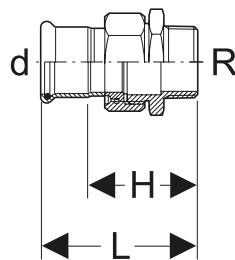
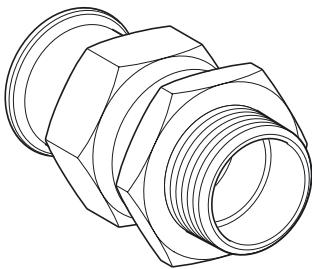

Application purposes

- For industry and shipbuilding
- Application overview – Geberit Mapress

Characteristics

- Pressing indicator
- Leaky if unpressed
- Seal ring made of CIIR, black
- Pressing socket with transparent protection plug

Technical data

Material CuNi10Fe1.6Mn, material no. 2.1972.11

Art. no.	DN	d, ø [mm]	R [°]	G [°]	L [cm]	H [cm.]	SU2 [pc.]
67232	12/15	15	1/2	3/4	8.1	6.1	10
67234	20/15	22	1/2	1	8.4	6.3	10
67243	20	22	3/4	1	8.5	6.4	10
67235	25	28	1	1 1/4	9.6	7.3	10
67236	32	35	1 1/4	1 1/2	10.4	7.8	10
67237	40	42	1 1/2	1 3/4	10.9	7.9	4
67238	50	54	2	2 3/8	12.4	8.9	4

Geberit Mapress CuNiFe flange PN 6, with pressing socket

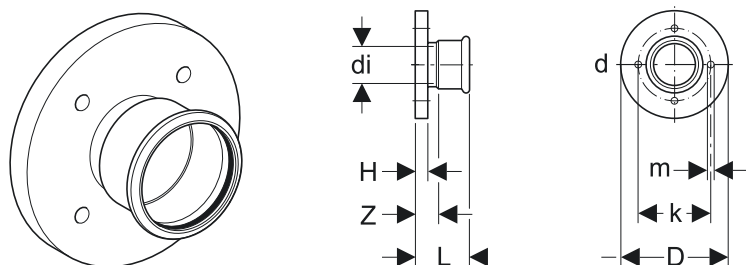

Application purposes

- For industry and shipbuilding
- Application overview – Geberit Mapress

Characteristics

- Pressing indicator
- Leaky if unpressed
- Seal ring made of CIIR, black
- Pressing socket with transparent protection plug
- Design B1 (raised sealingstrip with standard sealing strip), EN 1092-3

Technical data

Material CuNi10Fe1.6Mn, material no. 2.1972.11

Art. no.	DN	d, ø [mm]	di, ø [mm]	D [cm]	k [mm]	m [mm]	L [cm]	l [cm]	Z [cm]	n [pc.]	PN [bar]	SU1 [pc.]
68682	15/12	15	14.1	8	55	11	5.9	1	3.9	4	6	1
68684	20	22	19	9	65	11	6.3	1	4.2	4	6	1
68685	25	28	25.2	10	75	11	6.7	1	4.4	4	6	1
68686	32	35	32	12	90	14	6.8	1	4.2	4	6	1
68687	40	42	39	13	100	14	7.7	1.2	4.7	4	6	1
68688	50	54	51	14	110	14	8.5	1.4	5	4	6	1
68689	65	76.1	71.9	16	130	14	11.8	1.6	6.5	4	6	1
68690	80	88.9	84.7	19	150	18	12.3	1.6	6.3	4	6	1
68691	100	108	103.8	21	170	18	12.8	1.8	5.3	4	6	1

Geberit Mapress CuNiFe flange PN 10/16, with pressing socket

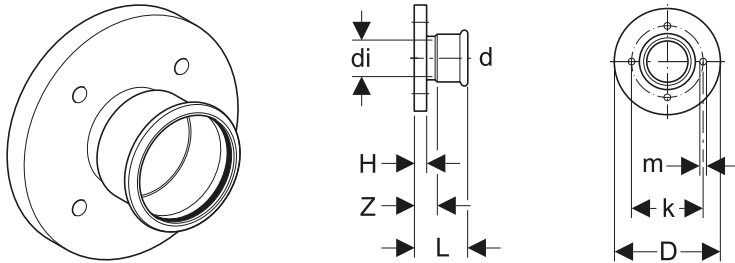

Application purposes

- For industry and shipbuilding
- Application overview – Geberit Mapress

Characteristics

- Pressing indicator
- Leaky if unpressed
- Seal ring made of CIIR, black
- Pressing socket with transparent protection plug
- Design B1 (raised sealing strip with standard sealing strip), EN 1092-3

Technical data

Material CuNi10Fe1.6Mn, material no. 2.1972.11

Art. no.	DN	d, ø [mm]	di, ø [mm]	D [cm]	k [mm]	m [mm]	L [cm]	l [cm]	Z [cm]	n [pc.]	PN [bar]	SU1 [pc.]
68692	15/12	15	14.1	9.5	65	14	6.1	1.6	4.1	4	10/16	1
68694	20	22	19	10.5	75	14	6.5	1.8	4.4	4	10/16	1
68695	25	28	25.2	11.5	85	14	6.9	1.8	4.6	4	10/16	1
68696	32	35	32	14	100	18	7.2	1.8	4.6	4	10/16	1
68697	40	42	39	15	110	18	7.9	1.8	4.9	4	10/16	1
68698	50	54	51	16.5	125	18	8.7	1.8	5.2	4	10/16	1
68699	65	76.1	71.9	18.5	145	18	11.8	1.8	6.5	4	10/16	1
68700	80	88.9	84.7	20	160	18	12.5	2	6.5	8	10/16	1
68701	100	108	103.8	22	180	18	13	2	5.5	8	10/16	1

Geberit Mapress CuNiFe flanged stub with plain end, for loose flange PN6

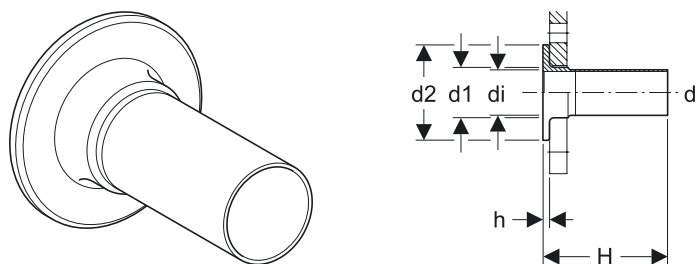

Application purposes

- For industry and shipbuilding
- Application overview – Geberit Mapress

Characteristics

- Suitable for loose flange, in accordance with EN 1092-3, flange type 02

Technical data

Material CuNi10Fe1.6Mn, material no. 2.1972.11

Art. no.	DN	d, \varnothing [mm]	da [mm]	di, \varnothing [mm]	D [cm]	H [cm]	h [cm]	K [cm]	PN [bar]	SU1 [pc.]
68756	20	22	27	19	5	13.5	0.6	3.9	6	1
68757	25	28	32	25	6	13.5	0.6	3.7	6	1
68758	32	35	40	32	7	13.5	0.6	2.7	6	1
68759	40	42	47	39	8	13.5	0.6	0	6	1
68760	50	54	59	51	9	13.5	0.8	0	6	1
68761	65	76.1	78	72.1	11	13.5	0.8	0	6	1
68762	80	88.9	91	84.9	12.8	13.5	1	0	6	1
68763	100	108	110	104	14.8	13.5	1	0	6	1

To order additionally

- Loose flange

Geberit Mapress CuNiFe flanged stub with plain end, for loose flange PN 10/16

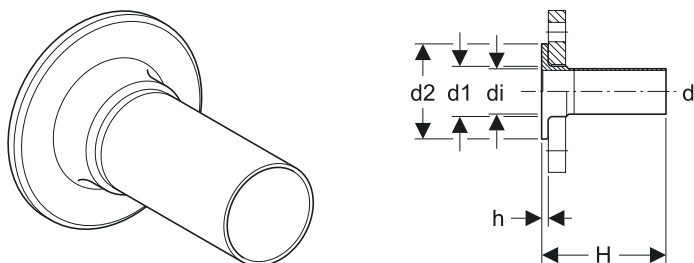

Application purposes

- For industry and shipbuilding
- Application overview – Geberit Mapress

Characteristics

- Suitable for loose flange, in accordance with EN 1092-3, flange type 02

Technical data

Material CuNi10Fe1.6Mn, material no. 2.1972.11

Art. no.	DN	d, ø [mm]	da, ø [mm]	di, ø [mm]	D [cm]	H [cm]	h [cm]	K [cm]	PN [bar]	SU1 [pc.]
68791	20	22	27	19	5.8	13.5	0.6	3.5	10/16	1
68793	25	28	32	25	6.8	13.5	0.6	3.7	10/16	1
68794	32	35	40	32	7.8	13.5	0.6	2.5	10/16	1
68795	40	42	47	39	8.8	13.5	0.6	0	10/16	1
68796	50	54	59	51	10.2	13.5	0.8	0	10/16	1
68797	65	76.1	78	72.1	12.2	13.5	0.8	0	10/16	1
68798	80	88.9	91	84.9	13.8	13.5	1	0	10/16	1
68799	100	108	110	104	15.8	13.5	1	0	10/16	1

To order additionally

- Loose flange

Feed-throughs

Geberit Mapress CuNiFe bulkhead and deck passing with two plain ends

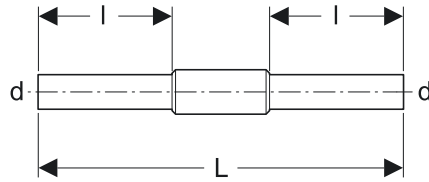
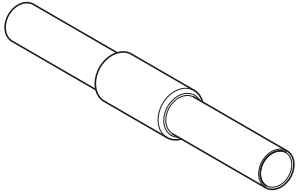

Application purposes

- For industry and shipbuilding
- Application overview – Geberit Mapress

Characteristics

- Protective tube for welding
- Protective tube made of steel 1.0039, coated

Technical data

Material CuNi10Fe1.6Mn, material no. 2.1972.11

Art. no.	DN	d, \varnothing [mm]	D [cm]	L [cm]	l [cm]	SU1 [pc.]
92080	12	15	2.5	45	16.5	1
92082	20	22	3.4	45	16.5	1
92083	25	28	3.8	45	16.5	1
92084	32	35	4.5	45	16.5	1
92085	40	42	5.4	45	16.5	1
92086	50	54	7	45	16.5	1
92087	65	76.1	8.9	45	16.5	1
92088	80	88.9	10.8	45	16.5	1
92089	100	108	13.3	45	16.5	1

Preliminary Remarks

The base element for the pressed joint is a pressfitting designed for plastic shaping. A seal ring has been inserted in the crimp shaped ends of the pressfitting ex works.

Pressing operation

The pressfitting and system pipe are pressed on two planes:

Strength plane

The pressfitting and the system pipe are shaped. The mechanical strength of the connection is thereby achieved.

Tightness plane

The seal ring is shaped when the socket end is pressed. The elastic resilience of the seal ring ensures permanent tightness of the connection.



Pressed joint before pressing



Pressed joint after pressing

Pressing contour

The press connection is established with Geberit Mapress pressing jaws or pressing collars depending on the pipe dimension. This results in different pressing contours.

The pipe dimensions d12-35 are normally pressed with pressing jaws. If pressing jaws are used, a hexagonal pressing contour is formed.

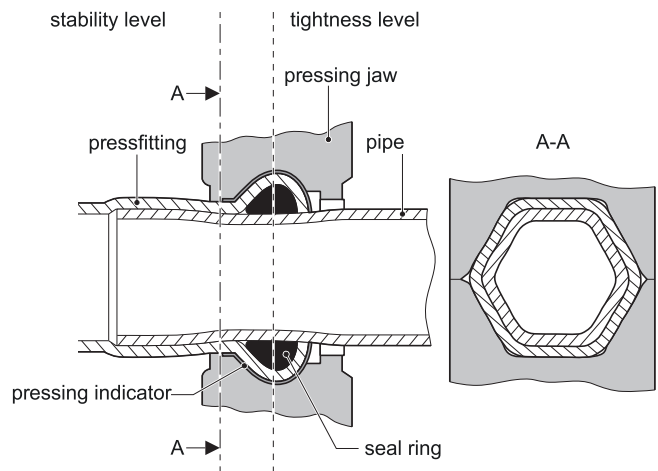

The pipe dimensions d42-108 are pressed with pressing collars and the corresponding adapters for pressing collars. When using pressing collars, a pressing contour referred to as a lemonshaped contour is formed.

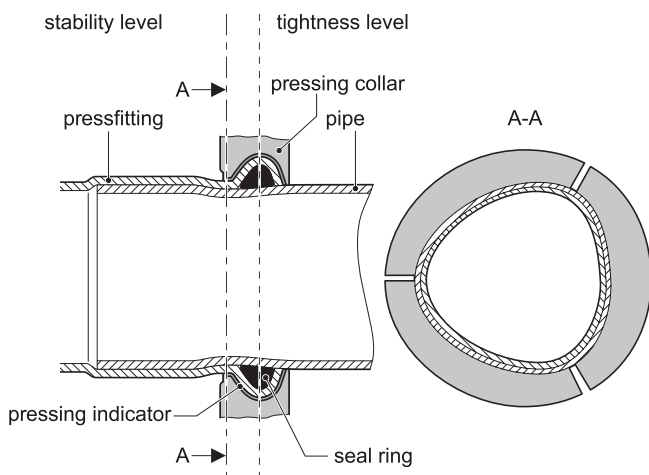

The fitting beads are provided with a pressing indicator at the factory. The pressing indicator has the following functions:

- Indicates to the plumber before the pressure test that there are unpressed connections
- Displays the dimensions of the fitting in unpressed status
- Colour indicates the type of product material concerned
- Clearly identifies the fitting as a Geberit product

The pressing indicator is destroyed by the pressing sequence and is subsequently removed by the plumber.

Geberit Mapress is characterised by the following features:

Quick

Lower labour costs in comparison to conventional connection technology

Clean

Extremely suitable for renovation of living areas
Seal rings are protected from dirt

Safe

No danger of fire as no welding or soldering necessary
Unpressed connections are easily identified
It is easy to distinguish between product materials using the indicator colours
Application ranges are easily identified by the plug colours
No danger of confusion with third-party products

Economical

No consumables such as oxygen or gas required

Simple

Simple connection technology

Universal

Can be used for surface-mounted and concealed installations

Hygienic

Meets the requirements of DVGW W 270 regarding microbiological safety

Experienced

More than 30 years of practical experience in pressing technology

Can be processed down to -20 °C

Can also be installed at low temperatures.

Pressing tools

Pressing tools compability [1]

Geberit pressing tool ACO 103plus [1], in case

Application purposes

- For pressing Geberit pressing systems

Characteristics

- Geberit compability [1]
- LED pressing point light
- With Bluetooth® interface for the NovoCheck app
- Hydraulic

Scope of delivery

- Battery-operated pressing tool [1], 12 V DC
- Battery charger
- BRUNOX® Turbo-Spray®
- 2 lithium-ion rechargeable batteries, 12 V / 1.5 Ah
- Case

Technical data

Nominal force	19kN
Protection class	III
Protection degree	IP20
Operating voltage	12V DC
Power consumption	240W
Rechargeable battery type	lithium-ion battery
Operating temperature	-20 – +60°C
Operating temperature, rechargeable battery	-10 – +50°C
Sound pressure level at user´s ear	75.5 dB(A)
Maximum sound power level	86.5 dB(A)
Vibration emission value	≤ 2.5 m/s ²
Weight	1.7 kg

Art. no.	Compability	Nominal voltage/ mains frequency	Power consumption [W]	Plug type	SU4 [pc.]	SU1 [pc.]
691.017.P5.1	[1]	230V/50–60 Hz	55	BS 1363 A	16	1

Geberit Li-ion battery 12V

Application purposes

- For Geberit pressing tools ACO 103plus
- For Geberit pressing tools ACO 102

Technical data

Rechargeable battery type	lithium-ion battery
Operating temperature	-10 – +50°C

Art. no.	Nominal voltage/ mains frequency	Battery capacity [Ah]	SU1 [pc.]
690.016.00.1 PO	12V DC	1.5	1

PO: Phase out as of April 2020

Geberit battery charger 12V

Application purposes

- For Geberit lithium-ion batteries 12 V
- For Geberit pressing tools ACO 103plus
- For Geberit pressing tools ACO 102

Technical data

Output Voltage	12 V DC
Charging current	3 A

Art. no.	Nominal voltage/mains frequency	Power consumption [W]	Plug type	Battery charge time	SU1 [pc.]
242.614.P5.1	220–240V / 50/60 Hz	55	BS 1363 A	30	1

Pressing tools compability [2]

Geberit pressing tool ACO 203 plus [2], in case

Application purposes

- For pressing Geberit pressing systems

Characteristics

- Geberit compability [2]
- LED

Scope od delivery

- Case

Technical data

Nominal force	32 kN
Protection class	III
Protection dagree	IP20
Operating voltage	18 V DC
Power consumption	450 W
Rechargeable battery type	lithium-ion battery
Operating temperature	-20 – +60°C
Operating temrerature, rechargeable battery	-10 – +50°C
Sound pressure level at user´s ear	78 dB(A)
Maximum sound power level	89 dB(A)
Vibration emission value	< 2.5 m/s ²
Weight	2.8 kg

Art. no.	Compability	Nominal voltage/mains frequency	Power consumption [W]	Plug type	SU4 [pc.]	SU1 [pc.]
691.218.P5.2	[2]	230 V / 50–60 Hz	90	BS 1363 A	16	1

Geberit Li-ion battery 18V

Application purposes

- For Geberit pressing tools ACO 203plus
- For Geberit pressing tools ACO 203XL plus
- For Geberit pressing tools ACO 202
- For Geberit pressing tools ACO 203
- For Geberit pressing tools ACO 203XL

Characteristics

- Charge level indicator

Technical data

Rechargeable battery type	lithium-ion battery
Operating temperature	-10 – +50°C

Art. no.	Nominal voltage/ mains frequency	Battery capacity [Ah]	SU1 [pc.]
690.016.00.1 PO	18 V DC	1.5	1
690.600.00.1	18 V DC	5	1

PO: Phase out as of April 2020

Geberit battery charger 18V

Application purposes

- For Geberit lithium-ion batteries 18 V
- For Geberit pressing tools ACO 203plus
- For Geberit pressing tools ACO 230XL plus
- For Geberit pressing tools ACO 202
- For Geberit pressing tools ACO 203
- For Geberit pressing tools ACO203XL

Technical data

Output Voltage	12 V DC
Charging current	3 A

Art. no.	Nominal voltage/mains frequency	Power consumption [W]	Plug type	Battery charge time	SU1 [pc.]
690.598.P5.1	220–240V / 50/60 Hz	90	BS 1363 A	30	1

Pressing tools compability [2XL]

Geberit pressing tool ACO 203XLplus [2] / [2XL], in case

Application purposes

- For pressing Geberit pressing systems

Characteristics

- Geberit compability [2]
- Geberit compability [2XL]
- Heat rotating
- With Bluetooth® interface for the NovoCheck app
- Hydraulic
- Brushless motor

Scope od delivery

- Battery-operated pressing tool [2XL] 18 V DC
- Battery charger
- BRUNOX® Turbo-Spray®
- 2 lithium-ion rechargeable batteries, 18 V / 1.5 Ah
- Case

Technical data

Nominal force	32 kN
Protection class	III
Protection dagree	IP20
Operating voltage	18 V DC
Power consumption	450 W
Rechargeable battery type	lithium-ion battery
Operating temperature	-20 – +60°C
Operating temrerature, rechargeable battery	-10 – +50°C
Sound pressure level at user´s ear	78 dB(A)
Maximum sound power level	89 dB(A)
Vibration emission value	< 2.5 m/s ²
Weight	3.8 kg

Art. no.	Compability	Nominal voltage/mains frequency	Power consumption [W]	Plug type	SU4 [pc.]	SU1 [pc.]
691.228.P5.2	[2], [2XL]	230 V / 50–60 Hz	90	BS 1363 A	16	1

Geberit Li-ion battery 18 V

Application purposes

- For Geberit pressing tools ACO 203plus
- For Geberit pressing tools ACO 203XLplus
- For Geberit pressing tools ACO 202
- For Geberit pressing tools ACO 203
- For Geberit pressing tools ACO 203XL

Characteristics

- Charge level indicator

Technical data

Rechargeable battery type	lithium-ion battery
Operating temperature	-10 – +50°C

Art. no.	Nominal voltage/mains frequency	Battery capacity [Ah]	SU1 [pc.]
690.599.00.1 PO	18 V DC	1.5	1
690.600.00.1	18 V DC	5	1

PO: Phase out as of April 2020

Geberit battery charger 18 V

Application purposes

- For Geberit lithium-ion batteries 18 V
- For Geberit pressing tools ACO 203plus
- For Geberit pressing tools ACO 203XLplus
- For Geberit pressing tools ACO 202
- For Geberit pressing tools ACO 203
- For Geberit pressing tools ACO 203XL

Technical data

Output voltage	18 V DC
Charging current	3 A

Art. no.	Nominal voltage/mains frequency	Power consumption [W]	Plug time	Battery charge time [min]	SU1 [pc.]
690.598.P5.1	220–240 V / 50–60 Hz	90	BS 1363 A	30	1

Tools for Geberit Mapress

Assortment overview – Geberit Mapress compatibility [1], [2], [3], [2XL] and [HCP]

Geberit Great Britain, Version: December 2019

	Art. no.	Dimension
Compatibillity [1]		
Geberit pressing tool ACO 103 plus [1], in case	691.017.P5.1	
Geberit Mapress set of pressing jaws [1]	690.190.00.1	12/15/18/22/28/35 mm
	690.192.00.1	15/18/22/28/35 mm
	690.191.00.1	15/18/22/28 mm
	690.193.00.1	15/22/28/35 mm
	690.195.00.1	12/15/22/28/35 mm
Geberit Mapress pressing jaw [1]	690.121.00.1	12mm
	690.122.00.1	15 mm
	690.123.00.1	18 mm
	690.124.00.1	22 mm
	690.125.00.1	28 mm
	690.126.00.1	35 mm
Compatibillity [2]		
Geberit pressing tool ACO 203plus [2], in case	691.218.P5.2	

	Art. no.	Dimension
Compatibillity [1]		
	690.230.00.1	12/15/18/22/28/35 mm
	690.231.00.1	15/18/22/28 mm
Geberit Mapress set of pressing jaws [2]	690.332.00.1	15/18/22/28/35 mm
	690.233.00.1	15/22/28/35 mm
	690.235.00.1	12/15/22/28/35 mm
	690.221.00.1	12 mm
	690.222.00.1	15 mm
Geberit Mapress pressing jaw [2]	690.223.00.1	18 mm
	690.224.00.1	22 mm
	690.225.00.1	28 mm
	690.226.00.1	35 mm
Geberit Mapress set of pressing collars [2], in case	691.296.00.2	42/54 mm
	691.297.00.3	42/54/66.7 mm
	691.181.00.1	35 mm
Geberit Mapress pressing collar [2], [3]	691.182.00.1	42 mm
	691.183.00.1	54 mm
	691.185.00.3	66.7 mm
Geberit adaptor jaw ZB 203A [2]	691.203.00.1	
Geberit pressing tool ACO 203XLplus [2]/ [2XL], in case	691.228.P5.2	
Geberit Mapress set of pressing collars [2XL], in case	691.188.00.1	76.1 / 88.9 mm
Geberit Mapress pressing collar set [2XL], in case	691.189.00.1	108 mm
	90797	76.1 mm
	90798	88.9 mm
	90799	108 mm

Geberit Great Britain, Version: December 2019

	Art. no.	Dimension
Compatibillity [1]		
Geberit Mapress adaptor jaw ZB 221 [2XL]	691.186.00.1	76.1 / 88.9 / 108 mm
Geberit Mapress adaptor jaw ZB 222 [2XL]	691.187.00.1	108 mm
Compatibillity [1]		

Pressing tools compatibility

Geberit Mapress set of pressing jaws [1]

Application purposes

- For technical building systems
- For pressing tools with Geberit compatibility [1]
- For pressing Geberit Mapress pressfittings

Characteristics

- Service-free
- Operable with one hand
- Zinc-plated
- Suitable for function test with Geberit PowerTest
- Easy maintenance and cleaning

Scope of delivery

- Pressing jaws
- Pipe cutter
- Pipe deburrer
- Insertion distance template with marker pen
- PowerTest

Art. no.	Compatibility	d, ø [mm]	SU1 [pc.]
690.190.00.1	[1]	12/15/18/22/28/35	1
690.195.00.1	[1]	12/15/22/28/35	1
690.191.00.1	[1]	15/18/22/28	1
690.192.00.1	[1]	15/18/22/28/35	1
690.193.00.1	[1]	15/22/28/35	1

Geberit Mapress set of pressing jaws [1]

Application purposes

- For technical building systems
- For pressing tools with Geberit compatibility [1]
- For pressing Geberit Mapress pressfittings

Characteristics

- Service-free
- Operable with one hand
- Zinc-plated
- Suitable for function test with Geberit PowerTest
- Easy maintenance and cleaning

Art. no.	Compatibility	d, ø [mm]	SU1 [pc.]
690.121.00.1	[1]	12	1
690.122.00.1	[1]	15	1
690.123.00.1	[1]	18	1
690.124.00.1	[1]	22	1
690.125.00.1	[1]	28	1
690.126.00.1	[1]	35	1

Pressing tools compatibility [2]

Geberit Mapress set of pressing jaws [2]

Application purposes

- For pressing tools with Geberit compatibility [2]
- For pressing Geberit Mapress pressfittings

Characteristics

- Service-free
- Operable with one hand
- Zinc-plated
- Suitable for function test with Geberit PowerTest
- Easy maintenance and cleaning

Scope of delivery

- Pressing jaws [2]
- Pipe cutter
- Pipe deburrer
- Insertion distance template with marker pen
- PowerTest

Art. no.	Compatibility	d, ø [mm]	SU1 [pc.]
690.121.00.1	[1]	12	1
690.122.00.1	[1]	15	1
690.123.00.1	[1]	18	1
690.124.00.1	[1]	22	1
690.125.00.1	[1]	28	1
690.126.00.1	[1]	35	1

Geberit Mapress set of pressing jaws [1]

Application purposes

- For technical building systems
- For pressing tools with Geberit compatibility [1]
- For pressing Geberit Mapress pressfittings

Characteristics

- Service-free
- Operable with one hand
- Zinc-plated
- Suitable for function test with Geberit PowerTest
- Easy maintenance and cleaning

Art. no.	Compatibility	d, ø [mm]	SU1 [pc.]
690.121.00.1	[1]	12	1
690.122.00.1	[1]	15	1
690.123.00.1	[1]	18	1
690.124.00.1	[1]	22	1
690.125.00.1	[1]	28	1
690.126.00.1	[1]	35	1

Pressing tools compatibility [2]

Geberit Mapress set of pressing jaws [2]

Application purposes

- For pressing tools with Geberit compatibility [2]
- For pressing Geberit Mapress pressfittings

Characteristics

- Service-free
- Operable with one hand
- Zinc-plated
- Suitable for function test with Geberit PowerTest
- Easy maintenance and cleaning

Scope of delivery

- Pressing jaws [2]
- Pipe cutter
- Pipe deburrer
- Insertion distance template with marker pen
- PowerTest

Art. no.	Compatibility	d, ø [mm]	SU1 [pc.]
690.230.00.1	[2]	12/15/18/22/28/35	1
690.235.00.1	[2]	12/15/22/28/35	1
690.231.00.1	[2]	15/18/22/28	1
690.232.00.1	[2]	15/18/22/28/35	1
690.233.00.1	[2]	15/22/28/35	1

Geberit Mapress set of pressing jaws [2]

Application purposes

- For pressing tools with Geberit compatibility [2]
- For pressing Geberit Mapress pressfittings

Characteristics

- Service-free
- Operable with one hand
- Zinc-plated
- Suitable for function test with Geberit PowerTest
- Easy maintenance and cleaning

Art. no.	Compatibility	d, ø [mm]	SU1 [pc.]
690.221.00.1	[2]	12	1
690.222.00.1	[2]	15	1
690.223.00.1	[2]	18	1
690.224.00.1	[2]	22	1
690.225.00.1	[2]	28	1
690.226.00.1	[2]	35	1

Geberit Mapress pressing jaw [2]

Application purposes

- For pressing tools with Geberit compatibility [2]
- For pressing Geberit Mapress pressfittings

Art. no.	Compatibility	d, ø [mm]	SU1 [pc.]
90526 P	[2]	35	1

P: Phase out

Geberit Mapress pressing jaw [2]

Characteristics

- Can be equipped with six Geberit Mepla pressing jaws [2]
- Can be equipped with six Geberit Mapress pressing jaws [2] or [3]
- Can be equipped with Geberit Mepla deburring and calibration
- tool ø 16–50 mm
- Can be equipped with a Geberit Mapress pipe deburrer
- ø 12–54 mm
- Can be equipped with a Geberit Mapress pipe cutter up to
- ø 50 mm or Geberit scissors

Art. no.	Specification number	SU4 [pc.]	SU1 [pc.]
691.137.00.1	10C-II	24	1

Geberit case for pressing jaws [2], [3], with insert 10C-II

Characteristics

- Can be equipped with six Geberit Mepla pressing jaws [2]
- Can be equipped with six Geberit Mapress pressing jaws [2] or [3]
- Can be equipped with Geberit Mepla deburring and calibration
 - tool \varnothing 16–50 mm
- Can be equipped with a Geberit Mapress pipe deburrer
 - \varnothing 12–54 mm
- Can be equipped with a Geberit Mapress pipe cutter up to
 - \varnothing 50 mm or Geberit scissors
- Can be equipped with a Geberit Mapress pipe cutter up to
 - \varnothing 54 mm
- Can be equipped with a Geberit Mapress insertion distance
 - template with marker pen
- Can be equipped with a BRUNOX® Turbo-Spray® 100 ml
- Can be equipped with a Geberit grease pencil and a folding rule

Technical data

Material ABS

Art. no.	Specification number	SU4 [pc.]	SU1 [pc.]
691.137.00.1	10C-II	24	1

Geberit Mapress set of pressing collars [2], in case

Application purposes

- For pressing tools with Geberit compatibility [2]
- For pressing Geberit Mapress pressfittings

Scope of delivery

- Pressing collars
- Adaptor jaw ZB 203A [2]
- BRUNOX® Turbo-Spray®
- Insertion distance template with marker pen
- Case

Art. no.	Compatibility	d, ø [mm]	SU4 [pc.]	SU1 [pc.]
691.296.00.2	[2]	42/54	24	1
691.297.00.3	[2]	42/54/66.7		1

Geberit Mapress pressing collar [2], [3]

Application purposes

- For pressing tools with Geberit compatibility [2]
- For pressing tools with Geberit compatibility [2]
- For pressing Geberit Mapress pressfittings
- Dimension \varnothing 35 mm is exclusively suitable for pressing Geberit Mapress Stainless Steel and Carbon Steel for operating pressures up to 25 bar/2500 kPa

Characteristics

- Pressable with adaptor jaw ZB 203A [2]
- Pressable with adaptor jaw ZB 203 [2]
- Pressable with adaptor jaw ZB 203A [2], d35-54
- Pressable with adaptor jaw ZB 303 [3]

Art. no.	Compatibility	d, \varnothing [mm]	SU1 [pc.]
691.181.00.1	[2], [3]	35	1
691.182.00.1	[2], [3]	42	1
691.183.00.1	[2], [3]	54	1
691.185.00.1	[2], [3]	66.7	1

Geberit adaptor jaw ZB 203A [2]

Application purposes

- For pressing tools with Geberit compatibility [2]
- For pressing with Geberit Mepla pressing collars [2]
ø 63–75 mm
- For pressing with Geberit Mapress pressing collars
[2] ø 35–66.7 mm

Characteristics

- Service-free
- Operable with one hand
- Zinc-plated
- Easy maintenance and cleaning

Art. no.	Compatibility	SU1 [pc.]
691.203.00.1	[2]	1

Pressing tools compatibility [2XL]

Geberit Mapress set of pressing collars [2XL], in case

Application purposes

- For Geberit pressing tools ACO 203XL
- For pressing Geberit Mapress pressfittings

Scope of delivery

- Pressing collars
- Adaptor jaw ZB 221 [2XL]
- BRUNOX® Turo-Spray®
- Insertion distance template with marker pen
- Case

Art. no.	Compatibility	d, ø [mm]	SU1 [pc.]
691.188.00.1	[2XL]	76.1/88.9	1

Geberit Mapress pressing collar set [2XL], in case

Application purposes

- For Geberit pressing tools ACO 203XL
- For pressing Geberit Mapress pressfittings

Scope of delivery

- Pressing collar, ø 108 mm
- Adaptor jaw ZB 222 [2XL] for final pressing
- BRUNOX® Turbo-Spray®
- Insertion distance template with marker pen
- Case

Art. no.	Compatibility	d, ø [mm]	SU1 [pc.]
691.189.00.1	[2XL]	108	1

Geberit Mapress pressing collars [2XL]/ [3]

Application purposes

- For pressing tools with Geberit compatibility [2XL]
- For pressing tools with Geberit compatibility [3]
- For pressing Geberit Mapress pressfittings

Art. no.	Compatibility	d, ø [mm]	SU1 [pc.]
90797	[2XL], [3]	76.1	1
90798	[2XL], [3]	88.9	1
90799	[2XL], [3]	108	1

Geberit Mapress adaptor jaw ZB 221 [2XL]

Application purposes

- For pressing tools with Geberit compatibility [2XL]
- For final pressing with Geberit Mapress pressing collars [2XL] / [3] ø 76.1 und ø 88.9 mm

Scope of delivery

- Case

Art. no.	Compatibility	d, ø [mm]	SU1 [pc.]
691.186.00.1	[2XL]	76.1/88.9/108	1

Geberit Mapress adaptor jaw ZB 222 [2XL]

Application purposes

- For pressing tools with Geberit compatibility [2XL]
- For final pressing with Geberit Mapress pressing collars [2XL] / [3] ø 108 mm

Scope of delivery

- Case

Art. no.	Compatibility	d, ø [mm]	SU1 [pc.]
691.187.00.1	[2XL]	108	1

Pressing tools compatibility [3]

Geberit Mapress set of pressing jaws [3]

Application purposes

- For pressing tools with Geberit compatibility [3]
- For pressing Geberit Mapress pressfittings

Scope of delivery

- Pressing jaws For pressing Geberit [3]
- Pipe cutter
- Pipe deburrer
- Insertion distance template with marker pen

Art. no.	Compatibility	d, ø [mm]	SU1 [pc.]
691.390.00.1 P	[3]	12/15/18/22/28/35	1
691.392.00.1 P	[3]	15/18/22/28/35	1
691.393.00.1 P	[3]	15/22/28/35	1

P: Phase out

Geberit Mapress set of pressing collars [3], in case

Application purposes

- For Geberit pressing tools ECO 3, ECO 301, ACO 3, EFP 3 and AFP 3
- For pressing Geberit Mapress pressfittings

Scope of delivery

- Pressing collars
- Adaptor jaw ZB 303 [3]
- BRUNOX® Turbo-Spray®
- Insertion distance template with marker pen
- Case

Art. no.	Compatibility	d, ø [mm]	SU1 [pc.]
691.396.00.2 P	[3]	42/54	1

P: Phase out

Geberit Mapress set of pressing collars [3], in case

Application purposes

- For Geberit pressing tools ECO 2 and ECO 301
- For pressing Geberit Mapress pressfittings

Scope of delivery

- Pressing collars
- Adaptor jaw ZB 323 [3]
- BRUNOX® Turbo-Spray®
- Insertion distance template with marker pen
- Case

Art. no.	Compatibility	d, ø [mm]	SU1 [pc.]
691.388.00.1 P	[3]	76,1/88.9	1

P: Phase out

Geberit Mapress pressing collars set [3], in case

Application purposes

- For Geberit pressing tools ECO 3, ECO 301
- For pressing Geberit Mapress pressfittings

Scope of delivery

- Pressing collars ø 108 mm
- Adaptor jaw ZB 303 [3] for final pressing
- BRUNOX® Turbo-Spray®
- Insertion distance template with marker pen
- Case

Art. no.	Compatibility	d, ø [mm]	SU1 [pc.]
691.389.00.1 P	[3]	108	1

P: Phase out

Geberit Mapress pressing collar [2], [3]

Application purposes

- For pressing tools with Geberit compatibility [2]
- For pressing tools with Geberit compatibility [3]
- For pressing Geberit Mapress pressfittings
- Dimension \varnothing 35 mm is exclusively suitable for pressing Geberit Mapress Stainless Steel and Carbon Steel for operating pressures up to 25 bar/2500 kPa

Characteristics

- Pressable with adaptor jaw ZB 203 A [2]
- Pressable with adaptor jaw ZB 203 [2]
- Pressable with adaptor jaw ZB 201 [2], d35–54
- Pressable with adaptor jaw ZB 303 [3]

Art. no.	Compatibility	d, \varnothing [mm]	SU1 [pc.]
691.181.00.1	[2], [3]	35	1
691.182.00.1	[2], [3]	42	1
691.183.00.1	[2], [3]	54	1
691.185.00.3	[2], [3]	66.7	1

Geberit Mapress pressing collar [2XL]/[3]

Application purposes

- For pressing tools with Geberit compatibility [2XL]
- For pressing tools with Geberit compatibility [3]
- For pressing Geberit Mapress pressfittings

Art. no.	Compatibility	d, \varnothing [mm]	SU1 [pc.]
90797	[2XL], [3]	76.1	1
90798	[2XL], [3]	88.9	1
90799	[2XL], [3]	108	1



wieland eucaro

Wieland Eucaro GmbH | Senator-Helmken-Straße 3 | 28197 Bremen | Germany
info@wieland-eucaro.de | www.wieland-eucaro.de

Diese Drucksache unterliegt keinem Änderungsdienst. Abgesehen von Vorsatz oder grober Fahrlässigkeit übernehmen wir für ihre inhaltliche Richtigkeit keine Haftung. Die Produkteigenschaften gelten als nicht zugesichert und ersetzen keine Beratung durch unsere Experten.